

CompuSpot®

Collision repair solutions that help increase profit today and prepare for tomorrow.



800 HF



Stabilizing foot

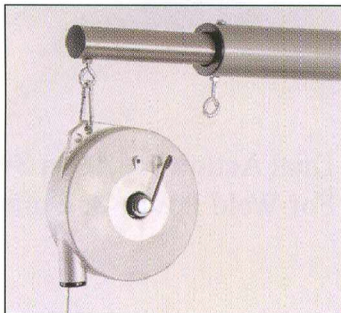

Stabilizing pulley



INVERTER

Liquid Cooled Inverter Spot Welder

- Liquid Cooled, 3 Phase, 14,000 Amp. Power Plant.
- Permanently Fixed Single & Double Side Spot Welding Guns.
- Max. Tip Pressure 550 daN (1,200 lb force).
- Backlit LCD Display for Program Selection.
- Digitally Controlled Programmable Weld Settings Enabling Factory Quality Welds.
- Complete With Dent Pulling Package for Welding : Pulling Washers, Rivets and Wiggle Wire Etc.

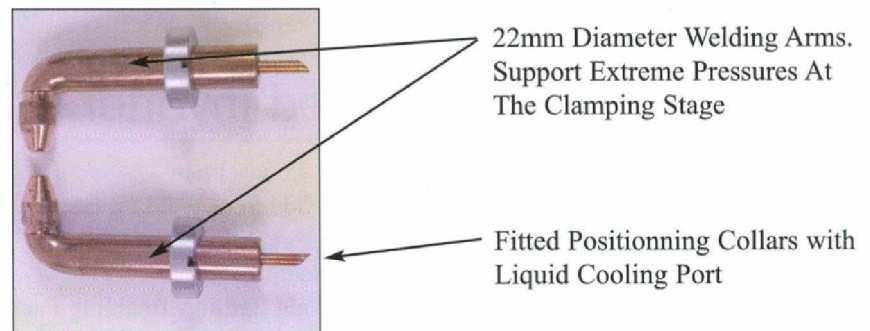
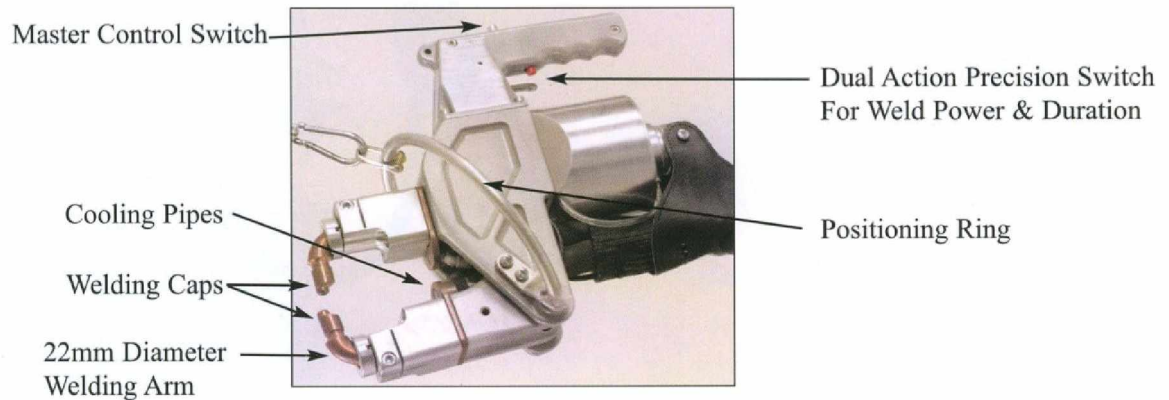
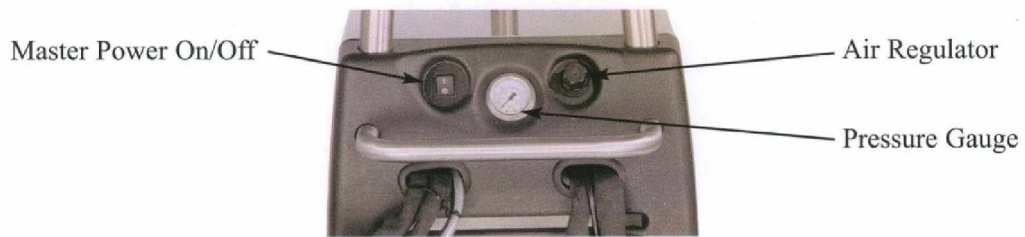



Clamp & Cable Supports



Easy Manipulation



Easy Access



Digital Readout on Main Control Panel

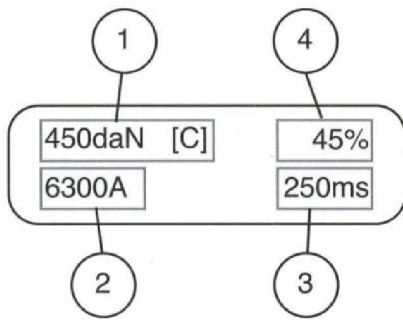

No.	Description
1.	Tip Pressure Confirmation
2.	Power Setting (Amps)
3.	Weld Time Selection
4.	Percentage of Power Selected

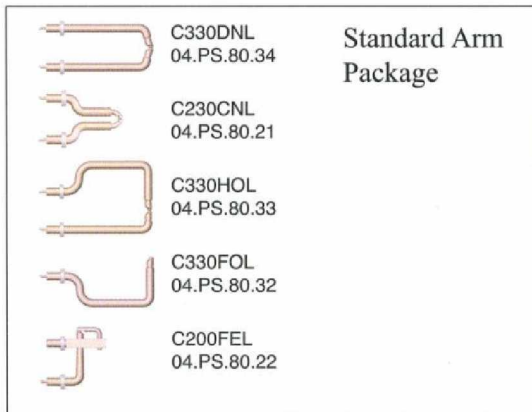

Full Range of Accessories Including ; Star Washers, Threaded Bolts, Rivets, Pulling Washers, Wiggle Wire, etc.

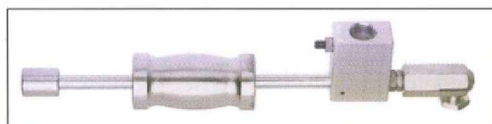

Quick Pull Slide Hammer for use with Single Side Gun
13.PS.10.28

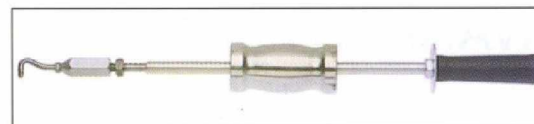

Standard Slide Hammer for use with Welded Washers or Nails
13.PS.10.26

CompuSpot	800-HF
Power Supply Requirements AC Input :	208-240V 3 phase
Main Frequency	50-60 Hz
Welding Current Regulation	YES-Automatic by processor
Max Welding Current (RMS)	14,000 Amps
Main Fuse	70 amp, slow blow
Welding Frequency	2000 Hz
Operating Air Pressure	8 bar (110 to 110 psi line pressure)
Electrode Force	550daN (125 mm Arms Set)
Electrode Arms Diameter	0,875"
Cooling Mechanism ; Circuits, Cables & Arms	Liquid (Sealed unit)
Nominal Operating Temp	86 degrees F
Weight of C Clamp (W/O Arms)	15.4 lb
Welding Cable Diameter / Length	350MCM / 8 ft. Liquid Cooled
Dimension (Excluding Boom) H / W / L	58 1/2" / 25 1/2" / 27 3/4"
Weight	532 lb

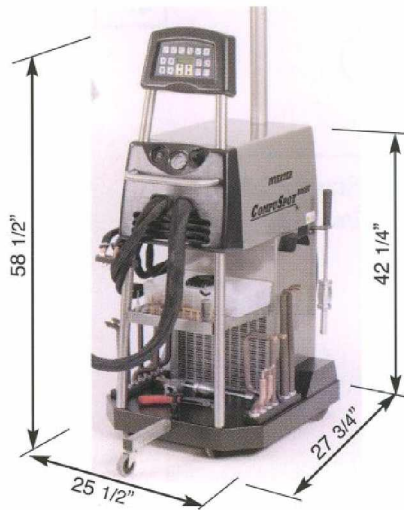

WARRANTY

Except as noted herein, this equipment is guaranteed to the original owner against defective materials or workmanship for a period of five (5) years from the date of delivery. Exceptions are as follows : A warranty of five (5) years on its transformer, diode, rectifier and choke, and two (2) years on the electronic circuit board and drive motor. In addition, all external components ; torches, cable assemblies, clamps, wheels and holders are warranted for a period of ninety (90) days. CONSUMABLE ITEMS such as tips, nozzles and electrodes ARE NOT COVERED UNDER WARRANTY.